

Product manual

VSN700 Data Logger



Table of Contents

System overview	5
VSN700 Data Logger models	6
Installation	7
Preparation	7
VSN700 installation.....	8
Inverter communication	11
Commissioning	12
Connect to the Internet.....	12
Configure the data logger	13
Configure for devices	14
Set a static IP address	14
Verify Internet connectivity to Aurora Vision servers	15
Asset registration	15
End-to-end data check	16
Plant Viewer access for end users	16
Adding an ABB weather station	18
Configuration for a weather station device	20
Interfacing VSN700-05 with SCADA systems.....	21
Aurora Protocol to SunSpec Adapter	21
Modbus TCP server	21
Data logger configuration for SCADA or other monitoring systems	22
Set a Static IP Address for the data logger	22
Configure the serial interfaces.....	22
Communication with devices by SCADA or monitoring system.....	24
Adding 3rd party devices	24
Modbus TCP client.....	26
Troubleshooting	27
Troubleshooting guide	27
Resetting the data logger	28
How to contact ABB technical support.....	30
Data logger specifications	31

Operators are required to read this manual and scrupulously follow the indications reported in it, since ABB cannot be held responsible for damages caused to people and/or things, or the equipment, if the warranty conditions are not observed.



IMPORTANT SAFETY INSTRUCTIONS

This manual contains important safety instructions that must be followed during installation and maintenance of the equipment.



SAVE THESE INSTRUCTIONS!

This manual must be considered as an integral part of the equipment, and must be available at all times to everyone who interacts with the equipment.

Symbols and signs

In the manual, the danger or hazard zones are indicated with signs, labels, symbols, or icons.



Generic hazard - Important safety information. This points out operations or situations in which staff must be very careful.



Hazardous voltage - This points out operations or situations in which staff must be very careful due to hazardous voltage.



This points out that it is mandatory to carry out the described operations using the clothing and/or personal protective equipment provided by the employer.



Positive pole and negative pole of the input voltage (DC)



This points out that the examined area must not be entered or that the described operation must not be carried out.

Not included in the supply



ABB accepts NO liability for failure to comply with the instructions for correct installation and will not be held responsible for systems upstream or downstream the equipment it has supplied. It is absolutely forbidden to modify the equipment. Any modification, manipulation, or alteration not expressly agreed with the manufacturer, concerning either hardware or software, shall result in the immediate cancellation of the warranty.

The Customer is fully liable for any modifications made to the system.

Given the countless array of system configurations and installation environments possible, it is essential to check the following: sufficient space suitable for housing the equipment; airborne noise produced depending on the environment; potential flammability hazards.

ABB will NOT be held liable for defects or malfunctions arising from: improper use of the equipment; deterioration resulting from transportation or particular environmental conditions; performing maintenance incorrectly or not at all; tampering or unsafe repairs; use or installation by unqualified persons.

ABB will NOT be held responsible for the disposal of: displays, cables, batteries, accumulators etc. The Customer shall therefore arrange for the disposal of substances potentially harmful to the environment in accordance with the legislation in force in the country of installation.

Field of use, general conditions

ABB shall not be liable for any damages whatsoever that may result from incorrect or careless operations.



You may not use the equipment for a use that does not conform to that provided for in the field of use. The equipment MUST NOT be used by inexperienced staff, or even experienced staff if carrying out operations on the equipment that fail to comply with the indications in this manual and enclosed documentation.

Intended or allowed use

This device is monitoring equipment designed for data collection and low-voltage connection to inverters, weather stations, string combiners, and other photovoltaic equipment.

System overview

The VSN700 series data loggers are a lightweight solution for remote data acquisition, which enables PV system owners to benefit from advanced energy reports. The data logger collects and analyzes energy generation data from all connected ABB (and legacy Power-One) solar inverters and other supported devices. System performance and energy information are logged into a database on the **Aurora Vision® Plant Management Platform** where it can be retrieved and used for analysis via any standard web-browser on an Internet connected device.

The installer logs on to the Aurora Vision website to register the VSN700 series data logger and ensures that the logger is correctly passing information to the servers. The installer provides a URL to the end user for access to Aurora Vision **Plant Viewer**. The installer can also monitor all of their sites through a web-browser using Aurora Vision **Plant Portfolio Manager**.

The VSN700 in conjunction with the Aurora Vision solution brings the following benefits:

- Safeguard Your Investment and Maximize Your Return
- Improved Solar Energy System Efficiency
- Lower Life Cycle Costs
- Real-time and Historic Data Presented Using Web-based Devices
- Alarm Functions and Device Communication Failure
- Remote Access to all Data Using Internet Technology

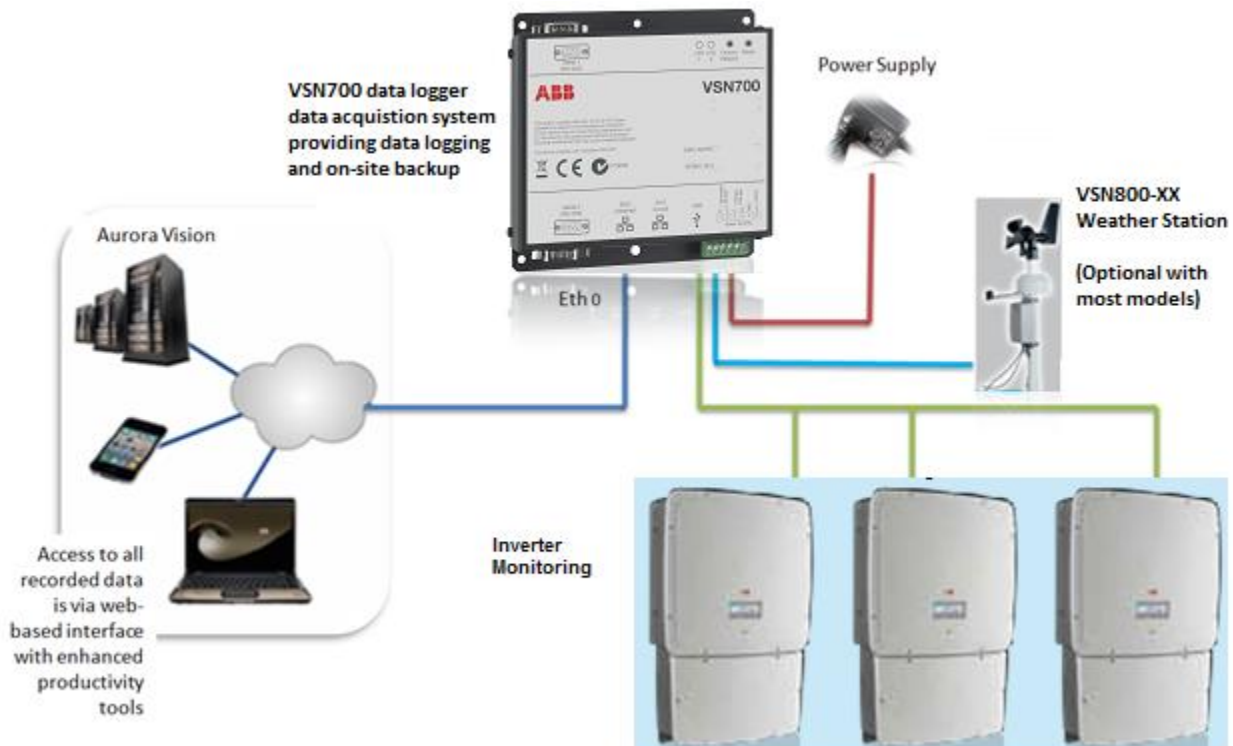

Commercial and Utility Application with VSN700-05

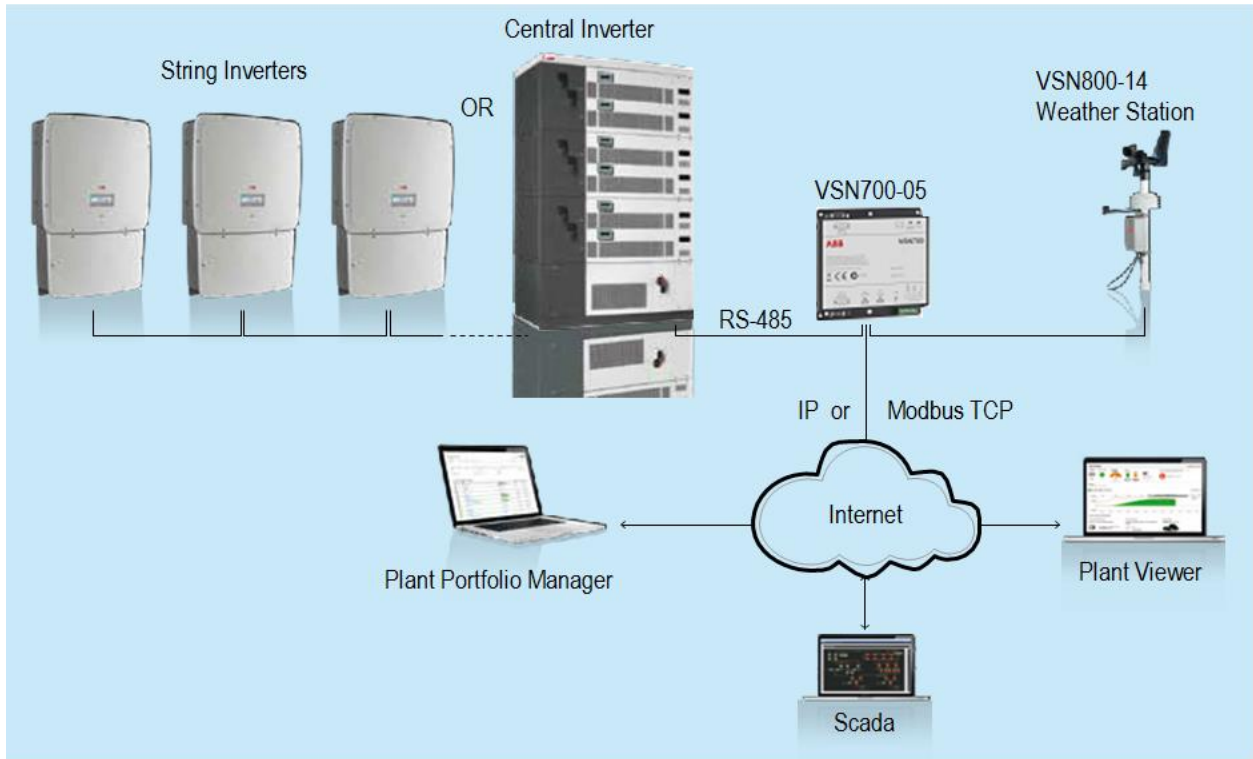

The information in this document applies to all VSN700 Data Logger models. This guide provides instructions for installing the data logger hardware to work directly with ABB (or legacy Power-One) solar inverters and for setting up the Aurora Vision management system for remote data access.

The VSN700 consists of a data **logger/gateway**, a **universal AC/DC power supply** adaptor, and optionally comes with a **DIN rail mounting kit**. The data logger connects to a Local Area Network (LAN) with an Ethernet RJ45 connection. Typically it connects to a Digital Subscriber Line (DSL) or Cable modem through a router to get access to the Internet. In summary, any kind of Internet connection will work.

VSN700 Data Logger models

The data logger comes in three models. The feature differences are provided in the table below.

Model	Supported Devices and Features
VSN700-01-XX (Residential)	Monitor up to 5 x ABB (or legacy Power-One) single-phase and/or small three-phase (Trio 5.8/7.5/8.5) string inverters.
VSN700-03-XX (Commercial)	Monitor up to 10 x ABB (or legacy Power-One) string inverters and 1 x ABB VSN800 Weather Station . String inverters can be single-phase or three-phase.
VSN700-05-XX (Max)	Monitor any ABB (or legacy Power-One) solar inverters. Monitor other supported ABB and 3rd party devices ; including, meters, combiners, and weather stations. Includes a Modbus TCP server and converts proprietary Power-One inverter data maps into SunSpec compliant Modbus data maps for easier SCADA system integration.

Installation

Qualified personnel with appropriate training and experience must perform the installation of the VSN700. Follow standard safety precautions during all procedures. Appropriate personal protection equipment (PPE), such as safety gloves and safety glasses is recommended.



During normal operation, dangerous voltages flow through many parts of the system, including: terminals, all I/O Modules (Inputs and Outputs) and their circuits. All Primary and Secondary circuits can, at times, produce lethal voltages and currents. Avoid contact with any current-carrying surfaces. Installation may also require close proximity to high-voltage high-current wires, so proper caution should be exercised when installing these devices.



Make sure all power is switched off before performing installation. These servicing instructions are for use by qualified personnel only. To reduce the risk of electric shock, do not perform any servicing other than that specified in the operating instructions unless you are qualified to do so.

Preparation

Make sure you have the following tools and materials prior to starting installation.

Tools

- Standard Electrician's Toolkit
- Personal Protective Equipment (Gloves, Goggles, Clothing)

Materials and Test Equipment

- Twisted-Pair RS-485 Wire (Belden#3106A or equivalent).
DO NOT USE CAT5/6 CABLE FOR THE RS-485 DATA WIRE.
- Ethernet Cable to make Network Connection
- Laptop Computer with Internet Browser
- Second Ethernet Cable for Logger configuration
- Mounting Screws and/or Brackets

It is also useful to know if you need to perform Asset Registration or final End-to-End Data Checks after physical installation is complete. If so, you will need a User **ID / password** to log in to Aurora Vision **Plant Portfolio Manager**, and additionally you will need Administrator privileges to access the **Administration** tool in Aurora Vision. See the "Commissioning" section for details.

VSN700 installation

1. Check packaging for all components:

- Data Logger
- Power Supply Adapter (not included with VSN700-05-00 model)
- DIN rail mounting kit for 35mm DIN rails (VSN700-05-00 model only)



2. Determine the indoor location of the VSN700.

For reliable operation, it is required that the data logger be located within 100m (330 ft.) of an Ethernet connection and within 1200m (4000 ft.) of the inverter(s).

3. Mount the data logger.

The logger comes with flanges with pre-drilled holes for easy mounting. A DIN rail mounting kit comes with the VSN700-05-00 model and can be optionally ordered with other models. All data logger versions require a weather protected site. The included power supply requires an ambient temperature between 0°C and 40°C but the logger can operate between -40°C and 85°C.

4. Connect shielded twisted-pair wire to the RS-485 terminals on the inverter(s). If there are multiple inverters, wire the inverters in a daisy chain configuration. Refer to your inverter manual for information on terminal locations and daisy chaining inverters. Use RS-485 data wire with one twisted pair, one ground conductor, and a shield with drain wire (Belden#3106A or equivalent).

DO NOT USE CAT5/6 CABLE FOR THE RS-485 DATA WIRE.

5. For systems with multiple inverters, the RS-485 network must be terminated at the final inverter by a switch near the RS-485 terminal block. The farthest inverter in the daisy chain must be terminated by setting the inverter termination switch to ON. For all other inverters in the daisy chain, turn OFF the termination switch. Below are pictures of RS-485 terminals in various inverters, as well as locations of the termination switch.¹ If you need more information, consult your inverter's manual for locating the RS-485 terminals and the termination resistor switch.

¹ In some environments you may experience poor RS-485 signal quality due to noise. If signal quality is a problem, double-check that the last inverter in the chain is terminated and other inverters are not terminated. If problems persist, it may prove helpful to attach a 120 Ohm 0.5 Watt resistor across screw terminals 1 and 2 on the data logger.

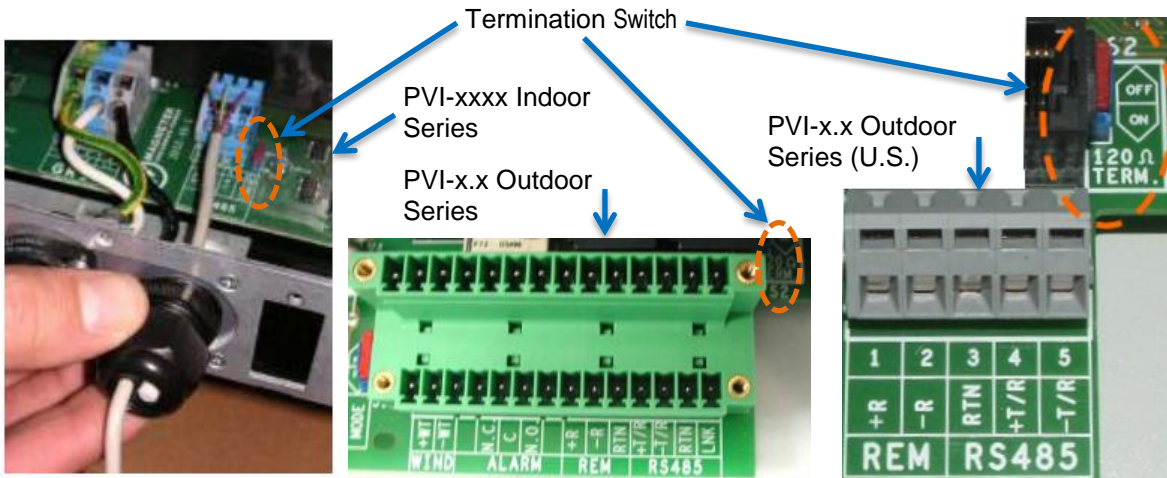

6. Connect the other end of the shielded twisted-pair wire to Secondary RS-485 terminals on the data logger. Use the table below and the figure on page the next page to make the proper connections. See the section on Adding an ABB Weather Station for information on connections for an attached weather station.

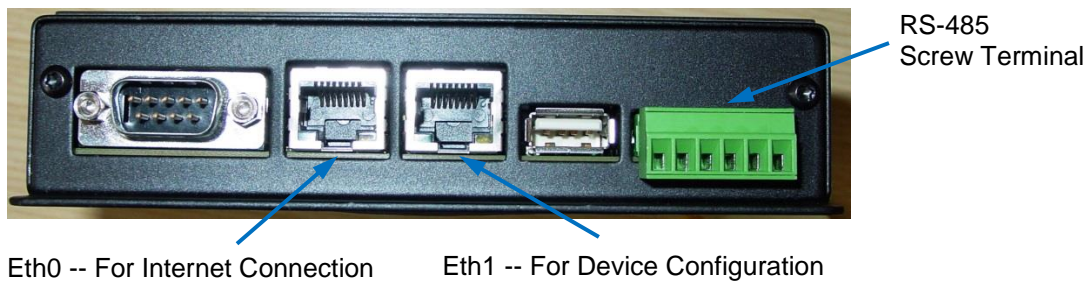

RS-485 Connection	Data Logger RS-485 Screw Terminal Connector	Example Inverter RS-485 Pin Label
RS-485 Negative (-)	1	-TR (Port 5)
RS-485 Positive (+)	2	+TR (Port 4)
RS-485 Negative (-)	3	----
RS-485 Positive (+)	4	----
Ground	5	RTN (Port 3)
VDC Power Only	6	----

7. Most VSN700 models come packaged with an AC/DC power adapter. The DC output wires are pre-stripped and tinned for connecting to the screw terminal of the data logger. Attach the conductor with the white label, which is positive 12 volts DC, to Port 6 of the data logger's screw terminal. Attach the other solid black DC ground conductor to Port 5 of the data logger's screw terminal. See the figure below.

VSN700-05-00 models come with a DIN Rail kit for mounting directly onto a DIN rail within an inverter. After DIN Rail mounting, connect the data logger directly to a 9V-24V ($\pm 10\%$) DC voltage source capable of supplying

greater than 7.2VA. The logger will typically only consume about 3VA during normal operation.

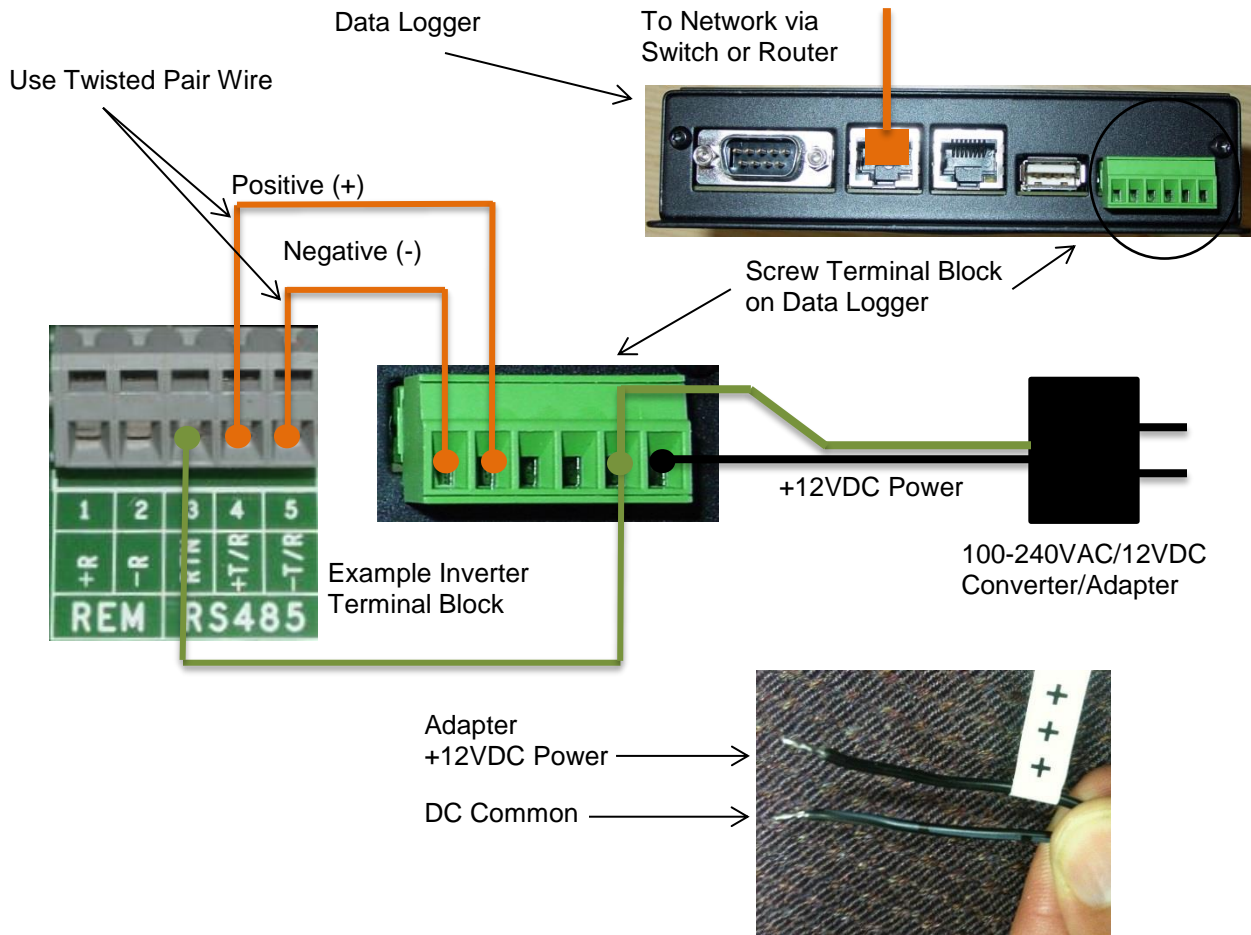

8. For models with an AC/DC adapter, connect the adapter to a standard power outlet. The power supply accepts a Universal AC input for use worldwide and will come with a plug adapter that is specific for your region. An appropriate travel adapter can be used if connecting to a different socket type.
9. Check the data logger's power. There is a pair of light emitting diodes (LEDs) on the side of the logger, opposite the RS-485/DC power terminal block. The LEDs flash during system boot and then LED2 turns solid green when power is supplied and the system is ready.

Inverter communication

ABB (and legacy Power-One) PVI and UNO inverter models use a proprietary communication protocol called **Aurora Protocol**. To monitor these inverters with a VSN700-01 (Residential) or VSN700-03 (Commercial) Data Logger model, they must be attached to the **Secondary RS-485** port on the data logger.

ABB PRO inverter models use **Modbus RTU** protocol and must be attached to the **Primary RS-485** port VSN700-03 (Commercial) Data Logger model. Modbus devices are not supported by the VSN700-01 (Residential).

The RS-485 ports on the VSN700-05 (Max) version are configurable for either protocol. Specific ABB (and legacy Power-One) inverters support both protocols and will have separate ports dedicated for each; consult your inverter's manual for its capabilities. In any case, all inverters (and other devices) connected in a particular daisy chain must use the same communication protocol and protocol settings. For systems with multiple inverters, each inverter in a daisy chain must be manually assigned a different RS-485 serial address. Refer to the inverter manual(s) for instructions on RS-485 wiring and setting the communication parameters like baud rate and RS-485 serial address.

Write down the serial number and RS-485 address for each inverter so you can determine which inverter is which on the monitoring system.

Commissioning

The following are the major steps required to make sure the system is operational and data is being passed to Aurora Vision servers:

1. Connect the data logger to your Ethernet network.
2. Configure the data logger through its web-based user interface.
3. Verify that you have a working Internet connection from the data logger to Aurora Vision's servers.
4. Perform Asset Registration through the **Administration** page on Aurora Vision (reachable from **Plant Portfolio Manager** web interface).
5. Verify end-to-end data transfer using the Aurora Vision Plant Portfolio Manager web portal.

Commissioning is not complete until you have performed the final two steps above over the Internet. However, these two steps do not necessarily need to be performed as part of the hardware installation.

Connect to the Internet

Connect the data logger to the Internet through a local area network. Use standard Ethernet cable and connect it to the Ethernet RJ-45 port marked **Eth0 (Internet)** on the front of the data logger. The data logger can connect through any switch or router in your network.²

Verify that the data logger has an Ethernet connection. The **Eth0 (Internet)** LED can be used for detecting network link and network traffic:

- Eth0 LED = GREEN = Link
- Eth0 LED = GREEN BLINK = Traffic
- Eth0 LED = OFF = No network link

If no activity is seen on the LEDs, double-check all connections.

ABB recommends a wired Internet connection because it is more reliable and requires less setup. If it is necessary to connect to a wireless network, a wireless network bridge with an Ethernet port is required. Purchase and configure the wireless network bridge that is compatible with the host wireless network. Ensure

² The data logger is by default set to DHCP and will try to acquire its IP-address from the DHCP server on your local network (LAN). The data logger is designed for use on an Ethernet network and must be assigned an IP address (DHCP or static) to make it accessible. If it is required to set a static IP for the data logger, your connection will not work until this address is set. If required, refer to the section below on setting a Static IP address. Normally no ports should need to be opened in the network firewall. The data logger will use port 443 outbound to transmit the data.

that the wireless connection is operational with a laptop before connecting it to the **Eth0 (Internet)** port of the data logger.

ABB does not provide Internet service or the cables required to connect the data logger to the Internet.

Configure the data logger

The installer must use a laptop with an Ethernet cable to communicate directly to the data logger's web-based user interface for configuration. The data logger's web server has many options and capabilities, but here we only describe those necessary to get your system up and running.

1. Configure the laptop's Ethernet port to obtain a Dynamic IP address automatically through DHCP; typically, laptops are already configured this way.
2. Connect the Ethernet cable between the secondary Ethernet port marked **Eth1 (Local)** on the data logger and the laptop computer.
3. Wait for the laptop to obtain an IP address from the data logger and then open an Internet browser window on the computer. Type in the following URL in the address bar.

http://172.17.17.1

4. The following **Home** page (or similar³) will appear:

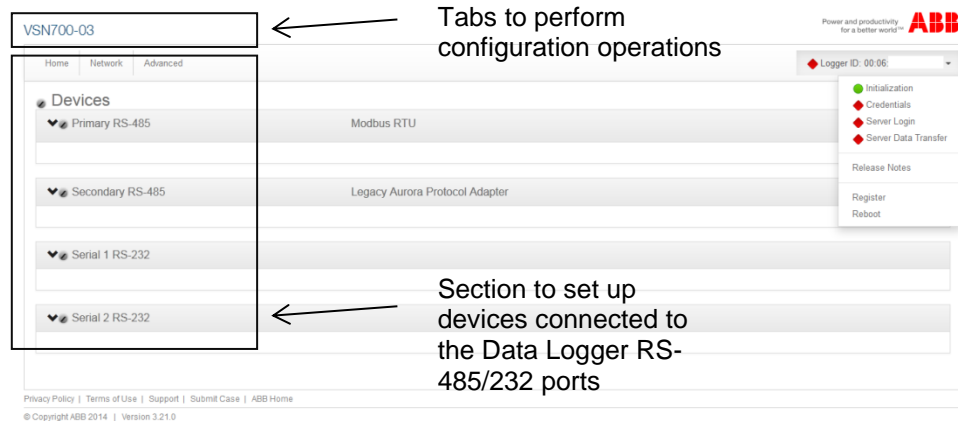

Select the tabs across the top to perform configuration operations and select one of the ports in the **Devices** list to set up devices.

Verify all the icons for the data logger in the status area to the right are green. It may take some time for all the icons to turn green.

³ Due to the constantly evolving nature of software, the images shown in this manual may be out of sync with the current user interface. The options mentioned should still be accessible, but may be renamed or accessed in a different way than is described in this manual. Check <https://docs.auroravision.net> for the latest version of this manual.

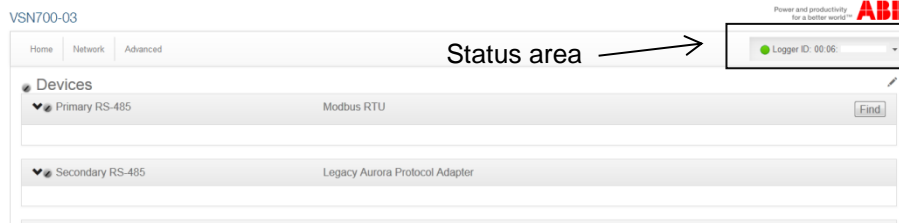

The MAC address (Logger ID) for the data logger is displayed at the top of the page. Be sure to write down the MAC address of the data logger. The MAC address is needed later for Asset Registration.

Configure for devices

The Devices list on the Home page shows all the different devices connected through all the ports on the data logger. It is essential that the devices you set up here match how devices are physically connected to your data logger.

By default, only the two RS-485 ports are set up. The primary RS-485 port is set to **Modbus RTU** and the secondary RS-485 is set to **Aurora Protocol (to SunSpec) Adapter**.

The default settings support hardware connections where all inverters that use Aurora protocol are attached as an RS-485 daisy chain to the **Secondary RS-485** port. Optional weather stations and supported inverters that use Modbus RTU are connected to the **Primary RS-485** port. See Section 4 if you are adding a VSN800 Weather Station. See Section 5 for advanced configuration options if you are using VSN700-05 (Max).

For the Secondary RS-485 connection, once inverters using the Aurora Protocol are properly addressed and wired in the RS-485 daisy chain, inverters will automatically be discovered and displayed.

Set a static IP address

Setting a Static IP is only necessary if required by your network. In almost all cases you can skip this section.

1. Obtain Static IP address information for the site.
2. Select the **Network** tab. Set the **Type** (Network Connection Type) field to **Static**. The page allows you to type in the following information:
 - IP address
 - Subnet Mask
 - Gateway
 - DNS (separate primary and secondary DNS servers with a single space)

3. Press **Update** at the bottom of the page.

The data logger needs to be restarted before the network changes take effect. In the **Home** tab use the **Reboot Logger** button to reboot the logger.

Verify Internet connectivity to Aurora Vision servers

1. Verify that the Ethernet cable is connected between the data logger's **Eth0 (Internet)** and your network.
2. The data logger acts as a router. From your laptop connected to **Eth1 (Local)**, verify internet connectivity by opening up an Internet browser window and connecting to www.auroravision.net.
3. The remaining steps for commissioning are performed via the Internet to check end-to-end communications. Proceed with one of the following steps:
 - If you are not responsible for these remaining steps, be sure to pass on the MAC address (Logger ID) information to the responsible party. Remove the cable from **Eth1**. Installation is complete.
 - If asset registration is already complete, proceed to the section on **End-to-End Data Check**.
 - If asset registration is not complete, proceed to the next section on **Asset Registration**.

Asset registration

Asset registration is performed via the Administration tool in Aurora Vision. Asset registration assigns the MAC address of your logger to a specific plant in Aurora Vision. Asset Registration can be performed before or after the on-site installation is complete. When you register the data logger, all the assets (inverters and other devices) reporting to the data logger are also registered. A Plant must be created on Aurora Vision using the Administration tool before the data logger can be assigned and registered to it. Note that access to Administration tool requires an Aurora Vision User ID and password with Administrator privileges.

From the data logger's user interface in the Logger ID drop-down menu, click the **Register** button to go to Asset Registration on the Administration page of the Plant Portfolio Manager. If you are not using the data logger's web-based user interface,

go to <https://admin.auroravision.net/customeradmin>. Select **Administration > Register Logger** and type in the MAC address of the data logger. Follow the steps on the Asset Registration page to select the plant that the data logger will be associated with.

See the Plant Portfolio Manager Users Guide for help in using the Administration tool for asset registration. Go to <https://docs.auroravision.net> for all the latest product documentation.

End-to-end data check

The last check is to make sure that data is actually being reported and is visible on the Aurora Vision portal. Wait 15 minutes and log on to www.auroravision.net using a web browser on an Internet connected device. Within Aurora Vision, go to the **Plants > Dashboard** page for the plant and open the **Device Status** panel. Verify that the energy readings agree with the inverter(s) and that all of the monitored devices are communicating, as indicated by the **Last Reported** time.

Plant Viewer access for end users

The installer must supply the user with their unique Plant Viewer URL so they can monitor their system. To find the URL for a specific user's plant within Aurora Vision, follow these steps:

1. Log on to Plant Portfolio Manager at www.auroravision.net and go to **Plants > Management**.
2. Select the Plant from the asset list in the screen area to the left.

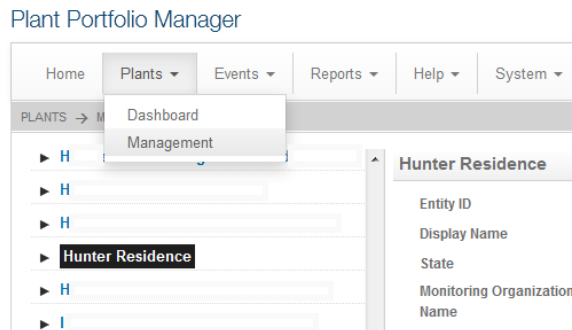

- Once the correct Plant is displayed, select **Plant Viewer** from the **Actions** menu.

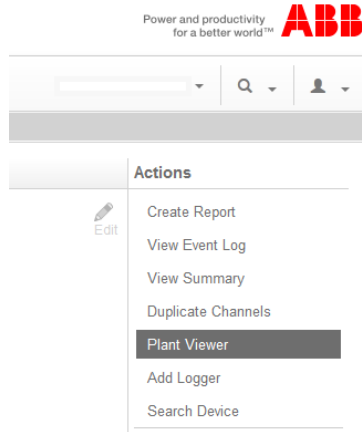

- A page is displayed to configure the user's Plant Viewer options. Scroll down to the **Published View** section. The URL to provide to the customer is in the **Share URL** field.

Hunter Residence

Customize

Company Logo
The company logo image will be displayed at the top of the dashboard page in the public 'kiosk' view

Choose Image

Note Images can be in PNG, GIF, or JPG format. Logo Images should be less than 1024px wide and 200px tall.

Public Display Options

Display Status

Display Address

Display Usage

Display Modules

Unit Preferences
Units that you want to be displayed on the kiosk

US Customary

Metric

Sharing Options

Public

Unshare

Published View

Share URL

```
<iframe style=padding:0px;margin:0px;border:none' height='1200' width='1000'
frameborder=0' scrolling=no' src=https://easyview.auroravision.net/easyview
/index.html?entityId=4 7> </iframe>
```

For detailed information about plant sharing options see the Plant Portfolio Manager User Guide. Go to <https://docs.auroravision.net> for all the latest product documentation.

Adding an ABB weather station

ABB's VSN800 Weather Station must be wired to the **Primary RS-485** port on VSN700-03 (Commercial version). Weather stations are not supported by VSN700-01 (Residential version). Weather stations can be attached to any port configured for Modbus RTU on VSN700-05 (Max version).

1. Connect shielded twisted-pair wire to the RS-485 terminals on the weather station. Use RS-485 data wire with one twisted pair, one ground conductor, and a shield with drain wire (Belden#3106A or equivalent). **DO NOT USE CAT5/6 CABLE FOR THE RS-485 DATA WIRE.**
2. Connect the other end of the shielded twisted-pair wire to the Primary RS-485 terminals on the data logger. Use the table below and the figure on the next page to make the proper connections.

RS-485 Screw Terminal

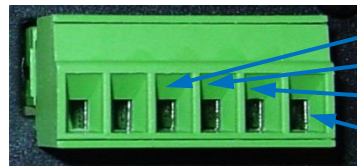
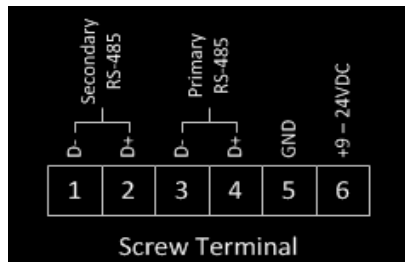

Primary RS-485 Connectors:

D-, Terminal 3 and

D+, Terminal 4

DC Common, Terminal 5

+12VDC Power, Terminal 6

RS-485 and Power Connections	Data Logger RS-485 Screw Terminal Connector	Example Inverter RS-485 Pin Label	Example VSN800-XX RS-485 Pin Label
RS-485 Negative (-)	1	-T/R	----
RS-485 Positive (+)	2	+T/R	----
RS-485 Negative (-)	3	----	RS-485 A(-)
RS-485 Positive (+)	4	----	RS-485 B(+)
DC Ground	5	RTN	RS-485 GND and GND
VDC+ Power Only	6	----	24VDC

3. The VSN800 Weather Station can tap the power terminals on the data logger for its power source. Tapping off the data logger's power source is optional; any appropriate DC power source that meets the specifications of the weather station may be used. To use the data logger's power source for the weather station, connect shielded twisted-pair wire to the power terminals on the weather/environmental station. For distances less than 400 feet between the data logger and the weather station we recommend using #22 AWG stranded copper wire. For longer distances use a heavier gauge wire. Consult the

VSN800 Weather Station datasheet for the minimum required voltage and maximum allowed wire gauge. If unable to meet these specs because of voltage drop then a separate power supply closer to the weather station must be used. **DO NOT USE CAT5/6 CABLE FOR THE POWER WIRES.**

4. Connect the other end of the shielded twisted-pair wire to the +9-24VDC and GND terminals (terminals 6 and 5) on the data logger. It may be necessary to use a wire nut to attach the multiple wires to the GND terminal on the data logger.

Wire the weather station to the data logger as shown in the figure below.

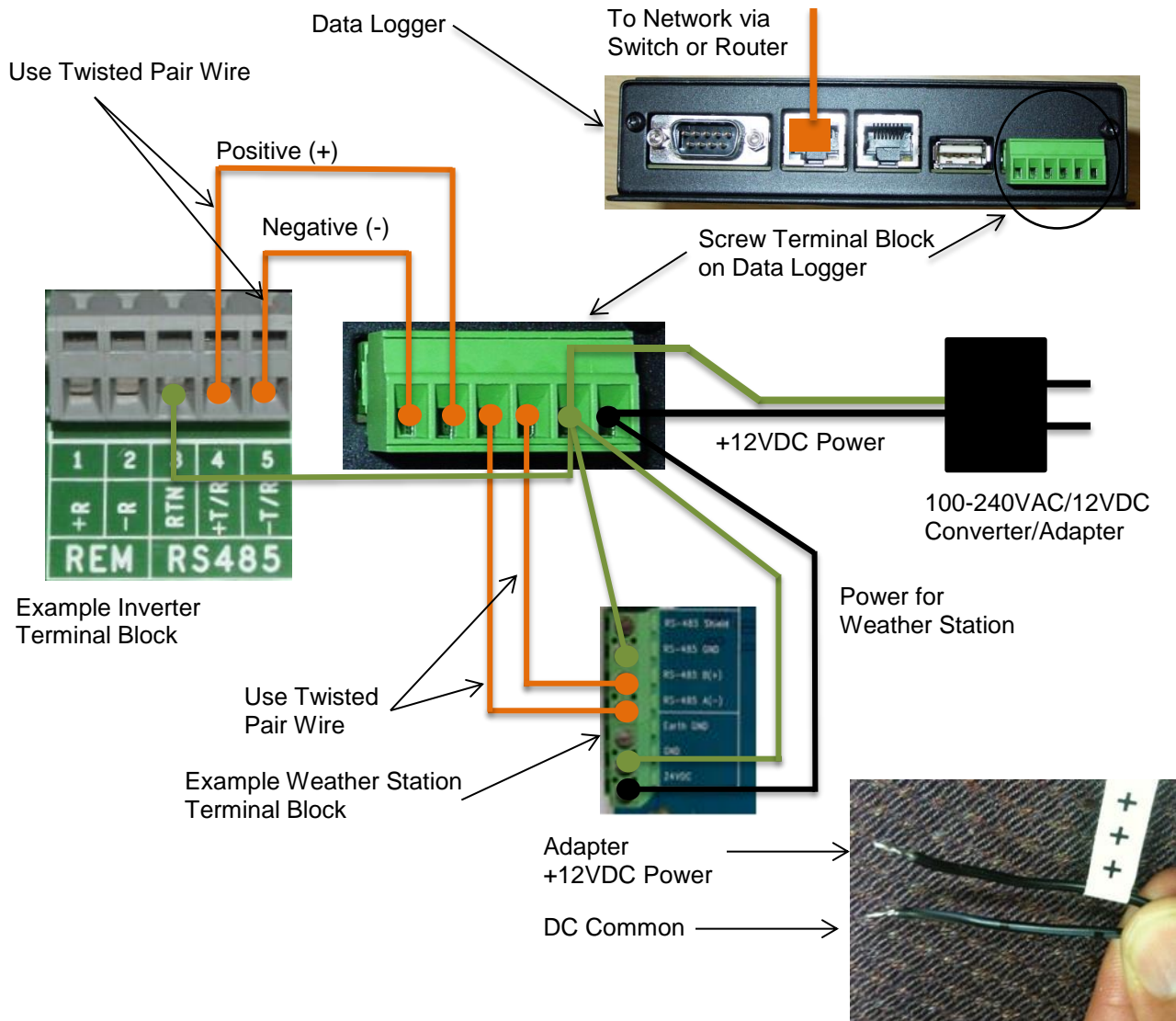

Configuration for a weather station device

The Devices list on the data logger's **Home** page will show all the different devices connected through all the ports on the data logger. It is essential that the devices you set up here match how devices are physically connected to your data logger.

The port configuration for the **Primary RS-485** port on the Commercial version VSN700 (VSN700-03) must remain set to **Modbus RTU** (default value) if adding an optional weather station.

Configure the **Primary RS-485** port using the following procedure. Bring up the data logger's web interface in the same manner as for configuring inverters (connect an Ethernet cable from the data logger's **Eth1 (Local)** port to a laptop and go to <http://172.17.17.1>).

To add the VSN800 weather station go to the **Home** tab and push the **Find** button for the **Primary RS-485** port. Click on **Start** in the window that pops up to begin the device discovery process. The default Modbus address for VSN800 Weather Station is 60. It is not necessary to let the scan finish, once it has discovered the device the scan can be stopped and closed. The weather station will be displayed as a **SunSpec Compatible Device**.

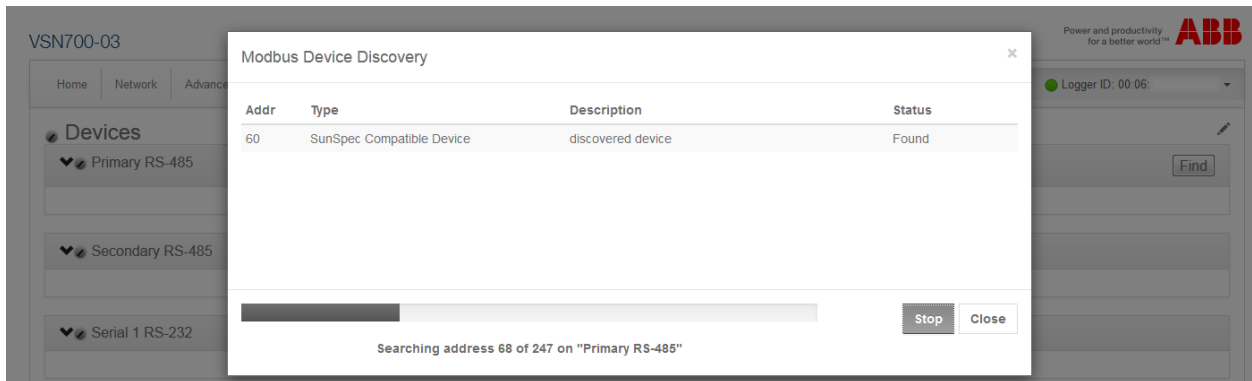
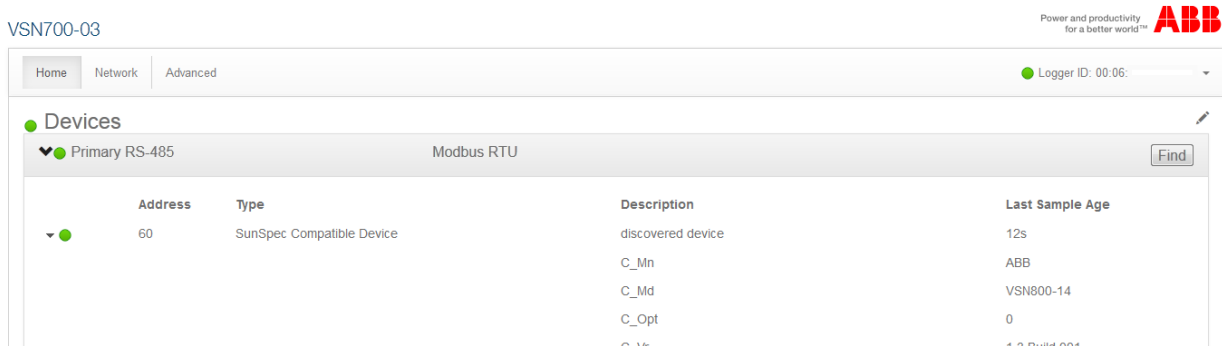

Interfacing VSN700-05 with SCADA systems

This section describes how to interface external monitoring or SCADA systems with the VSN700-05 data logger and is intended only for the Max version data loggers. This section does not apply to the Residential and Commercial versions. There are two important aspects of the data logger that allow for easy integration into a SCADA system, the Aurora Protocol to SunSpec Adapter and Modbus TCP communication.

Aurora Protocol to SunSpec Adapter

The data logger's **Aurora Protocol to SunSpec Adapter** is a software adapter that has two main functions

- it continuously polls inverters that use the proprietary Aurora Protocol as fast as it can
- caches data gathered from these inverters in SunSpec compliant Modbus data maps.

The SunSpec Alliance is a global trade alliance that aims to standardize how inverter data is stored.

This allows SCADA systems to use standard **Modbus TCP** read commands and a common SunSpec inverter data map to gather information from any ABB (or legacy Power-One) inverter that only supports Aurora Protocol. In addition, a SCADA system can send a supported Modbus write command to a SunSpec inverter control register and the data logger sends the equivalent Aurora protocol command(s) causing the inverter to execute a control action, such as grid disconnection or output power reduction.

Note that only inverters using the Aurora protocol have their data converted and cached in SunSpec compliant Modbus data maps.

For complete SunSpec specifications and open information standards, go to <http://www.sunspec.org/specifications/>.

Modbus TCP server

External monitoring or SCADA systems must communicate with the data logger using the **Modbus TCP protocol**. The data logger's **Modbus TCP server/gateway** converts and forwards onto the serial port(s) commands intended for Modbus RTU capable inverters or other Modbus RTU protocol devices connected to the data logger. The device response is then converted and forwarded back to the Modbus TCP client that sent the command.

The Modbus TCP server also communicates with the SunSpec Adapter allowing SCADA systems to gather data using Modbus TCP protocol from inverters which use the proprietary Aurora protocol. When a Modbus TCP client sends read commands intended for an inverter that is using Aurora protocol, the data logger's Modbus TCP server will respond based on data that has been cached for that inverter by the SunSpec adapter. When a Modbus TCP client sends a supported write command, the SunSpec adapter will send the equivalent Aurora protocol

command(s) to the inverter. If there are any problems with the command, an exception response will be sent back to the Modbus TCP client. There is no confirmation that a write command is successful and that the inverter has performed the control action; so, write commands should always be followed up shortly after with read commands to confirm the change(s).

Data logger configuration for SCADA or other monitoring systems

Set a Static IP Address for the data logger

Connect a PC to the **Eth1 (Local)** port of the data logger and browse to address <http://172.17.17.1> to access the data logger's web based configuration UI. In the **Network** tab configure a static IP address for the data logger's Eth0 port that is either within the same subnet as the SCADA system or can be routed to/from the SCADA system. Use a single space between your primary and secondary DNS servers, if applicable. Alternatively, the data logger can be set for DHCP if the DHCP server it receives its IP address from is configured to always assign the same IP address to the data logger.

Configure the serial interfaces

Configure the serial port interfaces for the appropriate communication protocols based on the devices installed at the site. If using inverters that only communicate using the Aurora protocol, then the serial interface they are connected to must be set for **Aurora Protocol (to SunSpec) Adapter** for the inverter's data to be accessible by Modbus TCP clients. Note that the ULTRA central inverter is only supported via **Modbus RTU** or via the **SunSpec Adapter** options; it is not supported via the **Legacy Aurora Protocol Adapter** option. Setting the interface for **Modbus RTU** will allow for better polling performance; however, advanced features like remote inverter firmware upgrade are only available through the **SunSpec Adapter** option.

In the **Home** tab click the pencil icon  and use the drop down menus to configure the Primary and Secondary RS-485 interfaces based on the type of devices connected to these ports. Polling performance is better if half of the devices are connected to one of the data logger's RS-485 ports and half connected to the other, though this may not be practical depending on the physical locations of devices or protocols used. Try to spread as many devices as possible across the two ports for better polling performance. The protocols used on each interface can be changed on the Max version data logger. They can both be set for the same protocol or different protocols. All devices daisy chained to a particular port must use the same communication protocol and settings as those set in the data logger for that port, including baud rate and parity checking. Note that to monitor the ULTRA central inverter via Modbus RTU, the baud rate for the interface on the data logger must be set for 19,200 bps.

Verify that both ports are configured to the appropriate baud rate and parity for the connected serial devices by clicking on the wrench icon  next to each interface to access the **Configure Interface** menu(s). If communicating with inverters via

Modbus TCP, open the port(s) in the firewall associated with the RS-485 interface(s) by clicking the wrench icon next to the red X to open the **Configure Global Settings** menu. The following image shows an example where one interface is configured for **Modbus RTU** and the other interface for **Aurora Protocol (to SunSpec) Adapter**.

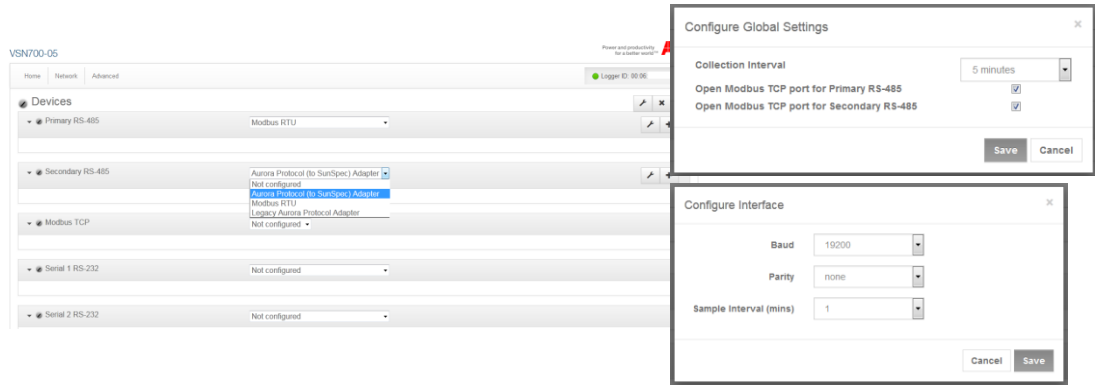

Save the changes by pressing the floppy disk icon. 

The logger needs to be rebooted for the configuration changes to take effect. In the drop-down menu by **Logger ID**, click on **Reboot**, and wait about a minute for the logger to fully reboot.

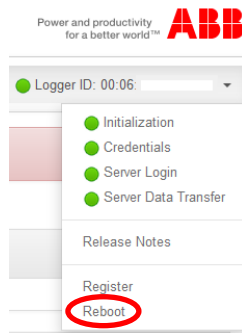

Now that the data logger has been configured, devices can be added to the logger either manually or by using the Find button(s). Devices using Aurora protocol will be automatically discovered.



Communication with devices by SCADA or monitoring system

The external monitoring or SCADA system communicates with the serial devices through the data logger's Modbus TCP server/gateway. The data logger's **Eth0 (Internet)** interface and the external system need to be on the same network subnet or have a route set up in order to communicate. The Modbus TCP ports must also be opened as previously described. The data logger forwards Modbus TCP traffic on port 502 to the Primary RS-485 interface and traffic on port 503 to the Secondary RS-485 interface. For example, to communicate with an inverter that uses Aurora protocol at RS-485 address 14 connected to the Primary RS-485 port which has been configured for **Aurora Protocol (to SunSpec) Adapter**, the Modbus TCP command would be pointed to: <Eth0_IP_address>:502:14. To communicate with a Modbus RTU device at RS-485 address 26 connected to the Secondary RS-485 port which has been configured for **Modbus RTU**, the Modbus TCP command would be pointed to: <Eth0_IP_address>:503:26.

Adding 3rd party devices

If you are adding supported 3rd party devices to VSN700-05 (Max version), follow the steps below to manually add the device. Alternatively, certain Modbus RTU devices can be auto-discovered using the Find button.

1. Go to the **Home** tab. Click on the Pencil icon  across from **Devices**. The following screen appears:

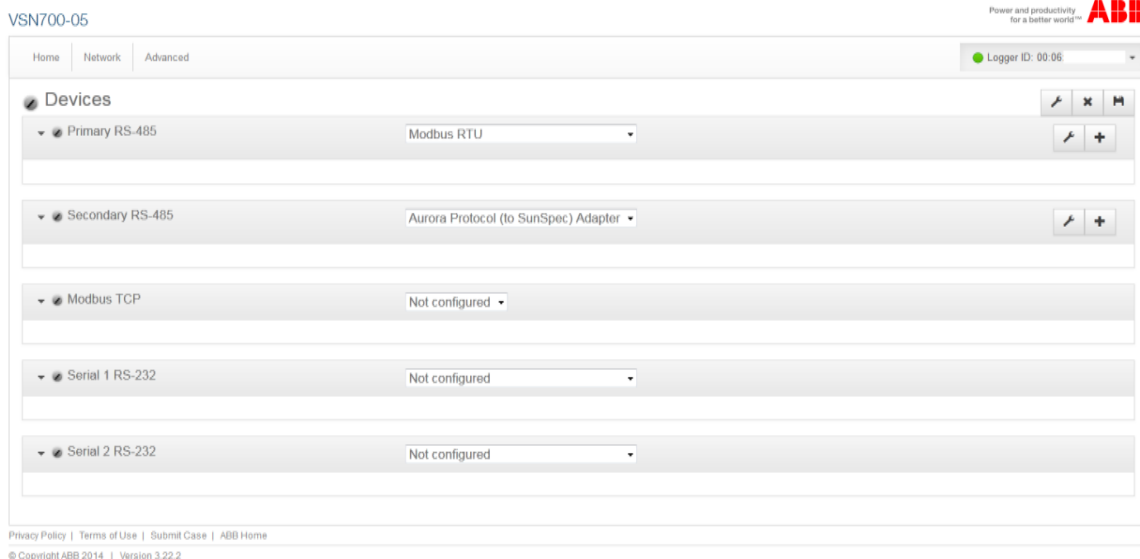

2. The screen shows the current configuration settings for each port. To add a device select the Plus  button on the RS-485 port that the device is connected to. A window appears to enter device settings.

3. Select the **Device Type** from the pull-down menu.
4. Set the **Slave Id** field to the RS-485 serial address of the device.
5. Enter a **Description** to help you identify the device if you need to change configurations later.
6. Click the **Add** button.
7. The device will be added to the **Devices** page, listed under the RS-485 port that it is connected to.
8. Press the Apply icon  at the top to commit the changes.

VSN700-05 Power and productivity for a better world™ **ABB**

Home | Network | Advanced ● Logger ID: 00:06: [dropdown]

Devices [edit] [delete] [apply]

▼ Primary RS-485 Modbus RTU [dropdown] [edit] [add]

Address	Type	Description
60	SunSpec Compatible Device	Weather Station Array 3

▼ Secondary RS-485 Aurora Protocol (to SunSpec) Adapter [dropdown] [edit] [add]

9. After making changes, you are returned to the **Devices** page with the status indicators, as shown below. After successfully collecting the first sample the indicator will turn green; click the black triangle next to the status indicator to verify the data collected is correct.

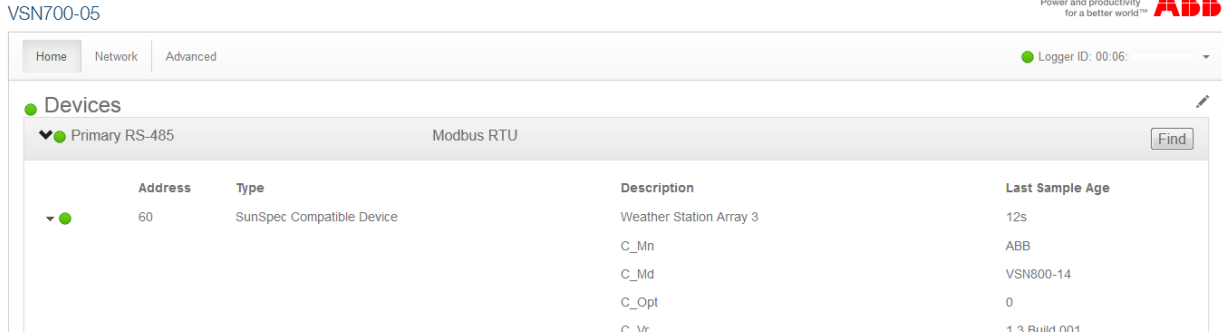

Modbus TCP client

In addition to Modbus TCP server functionality, the data logger is also capable of polling Modbus TCP devices using its Modbus TCP client interface. The Modbus TCP device must be on (or be routed to/from) the same LAN that the data logger's Ethernet interfaces (Eth0 and/or Eth1) are connected to. The Modbus TCP interface must also be enabled by clicking the pencil icon and then using the dropdown menu to enable it. Save this change using the Apply icon  and then the logger must be rebooted. Once rebooted, manually add devices to the Modbus TCP interface in a similar manner as described in the previous section. The type of device, its IP address, Modbus TCP server port, and its RS-485 address (slave Id) need to be specified. The IP Port will typically be 502 and the Slave Id will typically be 1 unless the device is behind a Modbus TCP gateway.

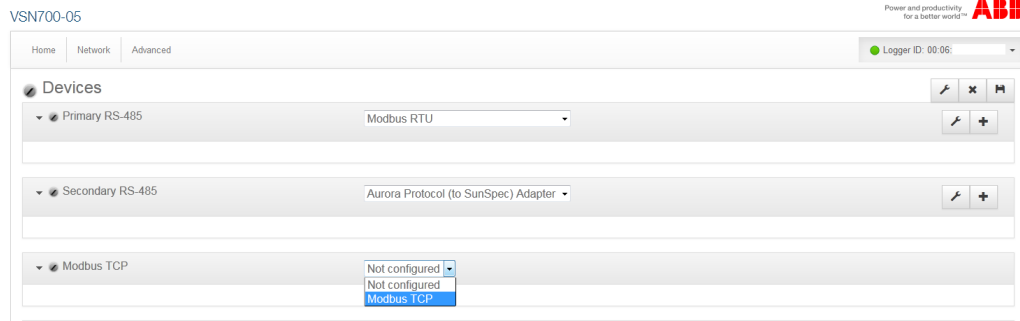

Add Device ✕

Device Type:

IP Address:

IP Port:

Slave Id:

Description:

Extra Config:

Troubleshooting

Troubleshooting guide

Issue: Aurora Vision does not show recent information from the monitoring system.

1. Verify the data logger is connected to power and the data logger's LED2 = GREEN.
2. Verify that the data logger has a network link, by checking that the **Eth0** LED on the data logger is green. If there is no network link then test the Ethernet (Cat-5 or better) cable with an appropriate data cable tester and verify the router, switch, or hub is operational.
3. Verify that you have a working Internet connection. This can be tested with a laptop by unplugging the Ethernet cable from Eth0 and connecting it to the laptop and testing to see if the laptop can connect to the Internet using the dynamic or static TCP/IP configuration for this network.
4. If all of the previous steps are correct restart the data logger by unplugging and then supplying power to the data logger.
5. If all of the previous steps do not help this issue, contact ABB Technical Support.

Issue: I cannot connect directly to the web interface on the data logger.

1. Verify the data logger is connected to power and the data logger's LED2 = GREEN.
2. Verify that you have a working Ethernet cable. One end of the cable should be connected to **Eth1** and the other to your computer's Ethernet port. You should see a link LED illuminated for both the data logger and the computer.
3. Verify the Network settings on the computer. The Network settings for the Ethernet connection should be set to DHCP "Automatically obtain an IP address". Try to "Repair" or release/renew the network connection on the computer.
4. If all of the previous steps don't help, restart the data logger by unplugging the power cord, wait 30 seconds, and then resupply power. Also restart your computer.
5. Try using a different Ethernet cable; your cable may be defective.

Issue: I do not see all of the inverters or devices.

1. Make sure that the inverter you do not see is on the list of supported inverters.
2. After 3 minutes select refresh on your web browser.
3. Close your web browser and reconnect to the data logger's **Home** page (<http://172.17.17.1>).
4. If the data logger restarts then it received a new configuration which should have all the devices defined. Wait for another three minutes and check the changes.
5. If all of the previous steps do not help this issue, contact ABB Technical Support.

Issue: I do not see recent data for an inverter.

1. Select refresh on your web browser.
2. Close your web browser and reconnect to the data logger's **Home** page (<http://172.17.17.1>).
3. Check to make sure the inverter has power. Check the inverter's user/installation manual.
4. Check to make sure the RS-485 communication wires are properly connected. Make sure the data conductors are not swapped. Measure the DC Voltage across D+ and D- at both the monitoring enclosure and at the data terminals of the remote device. If the measurement is 0V DC you have a short in the data wires. If the difference between the two measurements is greater than 3V DC then you may have an open circuit.
5. If all of the previous steps do not help this issue, contact ABB Technical Support.

Resetting the data logger

Consult this section if you suspect there is a problem with the data logger. Some problems can be fixed by rebooting the logger or by restoring the logger to its factory defaults.

NOTE: If the data logger was previously registered on Aurora Vision and a factory restore is performed, you have to contact ABB Technical Support to reset the data logger login credentials. Failure to reset the credentials will prevent the data logger to login to Aurora Vision.

On the end of the top side of the data logger housing (surface opposite the side with the Ethernet ports) are two small recessed buttons and two LEDs. The two buttons can be used to reset the system CPU (force a reboot) and to restore the unit to factory defaults. The two LEDs indicate the current status of the unit or the stage of the boot process.

Data Logger, Top Side



Checking the status LEDs on the logger is the first thing to do when troubleshooting a logger. A solid orange LED (or no LEDs lit when powered) is an indication that the logger is not running properly and may need replacement if the problem persists.

Press the Reset button closest to the corner of the data logger to reboot the unit. You need to wait until the logger is fully rebooted and then check to see if data is being transmitted correctly to see if this fixes the problem.

If problems persist, you may need to restore the data logger to factory defaults. Follow these steps to restore the data logger firmware to factory default.

1. Reboot the system. Momentarily press the Reset button on the logger or power cycle the logger.

2. Within 5 seconds of resetting or power cycling the logger, hold down Factory Restore button until both LEDs blink in a synchronized pattern. That is, both blink on and off at the same time. This should occur 15 to 30 seconds after step 1, depending on whether or not the Eth0 Ethernet interface is functional. If you cannot see the LEDs clearly, hold down Factory Restore button for 30 seconds to be sure.

The factory restore removes all user configurations but keeps any firmware upgrades. The ports have to be reconfigured as Modbus or Aurora Protocol if different than factory settings. Devices have to be rediscovered and any other configuration information added again. ABB Technical support must also be contacted to have the Aurora Vision credentials reset for that data logger.

The table below shows the meaning of LED indicators during the start-up process and normal operation.

Boot/Operation Stage	LED Indicators
Powered Off	Both LEDs off
First Stage Bootloader	Orange LED lit solid
Second Stage Bootloader	Orange and Green LEDs lit solid
Kernel loading	No LEDs lit
Resetting to Factory Default (only if triggered)	Both Orange and Green LEDs blink synchronized
System Initialization	Green and Orange LEDs blink alternately
Running normally	Green LED lit solid

How to contact ABB technical support

For technical support please go to www.abb.com/solarinverters. When requesting technical support, please provide the following information:

- Model #
- Unit serial number
- Site/project name
- Problem description

Be prepared to describe the problem you are experiencing including specific details of the application, installation, and any additional pertinent information.

In the event that the equipment needs to be returned to the factory for any reason, please call to obtain a RMA number (Return Merchandise Authorization). Do not return items without a RMA number displayed on the outside of the package.

If you require an advance replacement to be shipped before the RMA unit has been received by ABB, you will need to submit a valid purchase order for the replacement unit, referencing the RMA number on the P.O. When we receive the faulty unit, we will credit the cost of the replacement, if it is covered by the warranty.

Include a written statement describing the problems.

Send the package with shipping prepaid to our factory address. Insure your shipment. Our warranty does not cover damage incurred during transit.

Data logger specifications

Ethernet Network Connection

Primary Physical network connection on 10BaseT Ethernet or 100BaseTX Fast Ethernet networks using RJ45 twisted pair cable. (Port name - Eth0)

Secondary Physical network connection on 10BaseT Ethernet or 100BaseTX Fast Ethernet, limited to 12 MBit/s since connected through an internal USB port. (Port name - Eth1)

Serial Connection

- Two RS-232 serial ports terminated with 9 pin MALE D-SUB connectors. Support baud rates up to 230kbps.
- Two RS-485 serial ports supported on a single screw terminal block. Supports baud rates up to 115200 bps.

Devices Supported

- **VSN700-01 (Residential)**: Up to 5 ABB (or legacy Power-One) single-phase or small three-phase (Trio 5.8/7.5/8.5) string inverters.
- **VSN700-3 (Commercial)**: Up to 10 ABB (or legacy Power-One) string inverters and one ABB weather station. String inverters can be single-phase or three-phase.
- **VSN700-05 (Max)**: All ABB (or legacy Power-One) solar inverters. 3rd Party devices and other ABB devices are also supported; consult the latest supported devices list for an up-to-date list.

USB 2.0 Ports

The USB Ports are currently not used.

Hardware

- CPU: Atmel AT91SAM9260 @ 400MHz
- DRAM: 64 Mbytes
- Flash memory: 256 Mbytes

Power Supply

- Power: 9-24 VDC ($\pm 10\%$)
- Power consumption is typically between 2.8 VA and 3.2 VA. With load on USB bus, power consumption is between 5.0 VA and 7.2 VA

Operating Environment

- Temperature: -40°C to +85°C (Data logger device only)
Temperature: 0°C to +40°C (Data logger device plus AC/DC adapter)
- Humidity: <80% storage, <85% operating (non-condensing)

Dimension

- Height: 1.2" (3.05 cm) x Width: 5.35" (13.56 cm) x Length: 5.25" (13.34 cm)
- Weight: 1 lbs. (0.454 kg)

Compliance

The data logger is compliant with both industrial and light industrial/commercial EMC standards for both emission and immunity.

FCC Part 15 Class A; CISPR 22, EN 55022 Conducted and Radiated Emission; CISPR 24, EN55024 Immunity

Safety

EN 60950-1, UL/CSA 60950-1 (External AC/DC Power Supply Adapter)

IP Network Services

Any network connected to the logger must allow traffic to pass on the following ports. Network firewall rules (if present) must allow responses to the logger over existing TCP connections.

Direction	Service/Port	Protocol	Description
Out	ssh/22	Tcp	For remote debugging by ABB service personnel, the data logger utilizes encrypted SSH Remote Login Protocol. To allow service personnel remote access to the data logger, this port has to be opened in any firewall and forwarded to the data logger. (preferred)
Out	domain/53	Tcp/udp	The data logger must be able to resolve domain names, to ensure scalability and dynamic changes on the Internet (DNS). (required)
Out	https/443	Tcp	As an HTTP client, the data logger uses SSL/TLS protocol connections to Aurora Vision® servers for secure communication. The logger uses this port for all services, including data transmission, firmware upgrade, configuration management, and remote command transmission. (required)
Out	dhcp/67, dhcp/68	Udp	If DHCP service is not available, static network information must be assigned to the logger (preferred)
Out	ntp/123	Udp	The logger uses this port for network time services (NTP). (preferred)

Network Hosts

The logger will connect to the following hosts. Some servers owned by ABB, and others are customer or ISP servers. Servers listed as owned by “Customer IT/ISP” must be configured in the logger using either DHCP or as static network information.

Host	Purpose	Port	Owner/Manager
platform.auroravision.net	Data, configuration	TCP:443	ABB
gw1.auroravision.net and/or apt.fatspaniel.net	Logger firmware upgrade	TCP:443	ABB
Site dependent	DHCP (optional)	UDP:67, UDP:68	Customer IT/ISP
Site dependent	DNS	UDP:53, TCP:53	Customer IT/ISP

Logger Network Configuration

The logger requires a valid network configuration in order to operate. This information can either be provided by a DHCP server provided by the customers network (the default), or the logger can be configured with static network information. Regardless of how the logger is configured, the following information is required.

Configuration	Purpose
IP Address	Allows the logger to take part in the local network. This does not need to be a public IP address. In most cases this is a private IP address.
Subnet mask	Used to determine if two computers are on the same network.
Gateway	The IP address of the computer which will forward network traffic from the local network to an external network
DNS Server	The IP address(es) of the computer(s) which resolve domain names.

Contact us

www.abb.com/solarinverters